

Montage der Türen

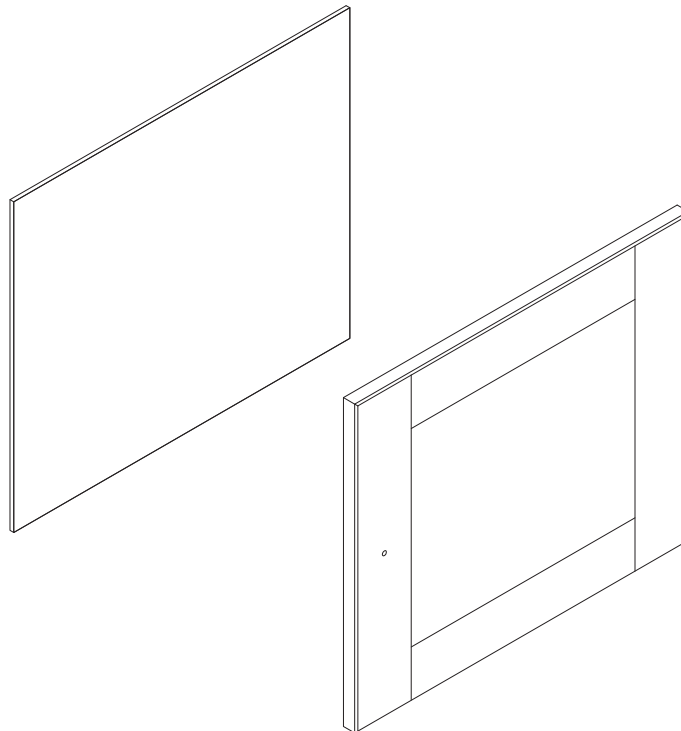
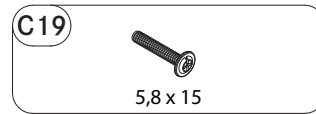
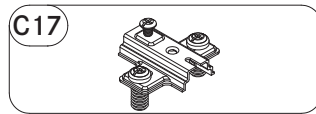
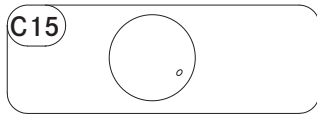
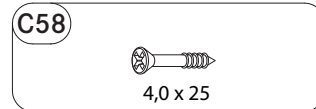
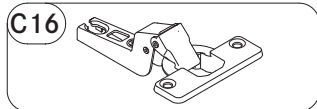
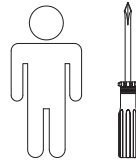
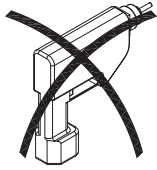

GT1
HT2
GT2
HT3
GT3

Hinweis: Die Rückwand muss jeweils bereits beim Zusammenbau der Stollen und Böden in die obere und untere Nut eingeschoben werden.
Bei Glastüren müssen zur Scharnier-Montage die Teile C22, C23 und C24 an den Öffnungen im Glas eingesetzt und mit der Schraube C21 fixiert werden.

1

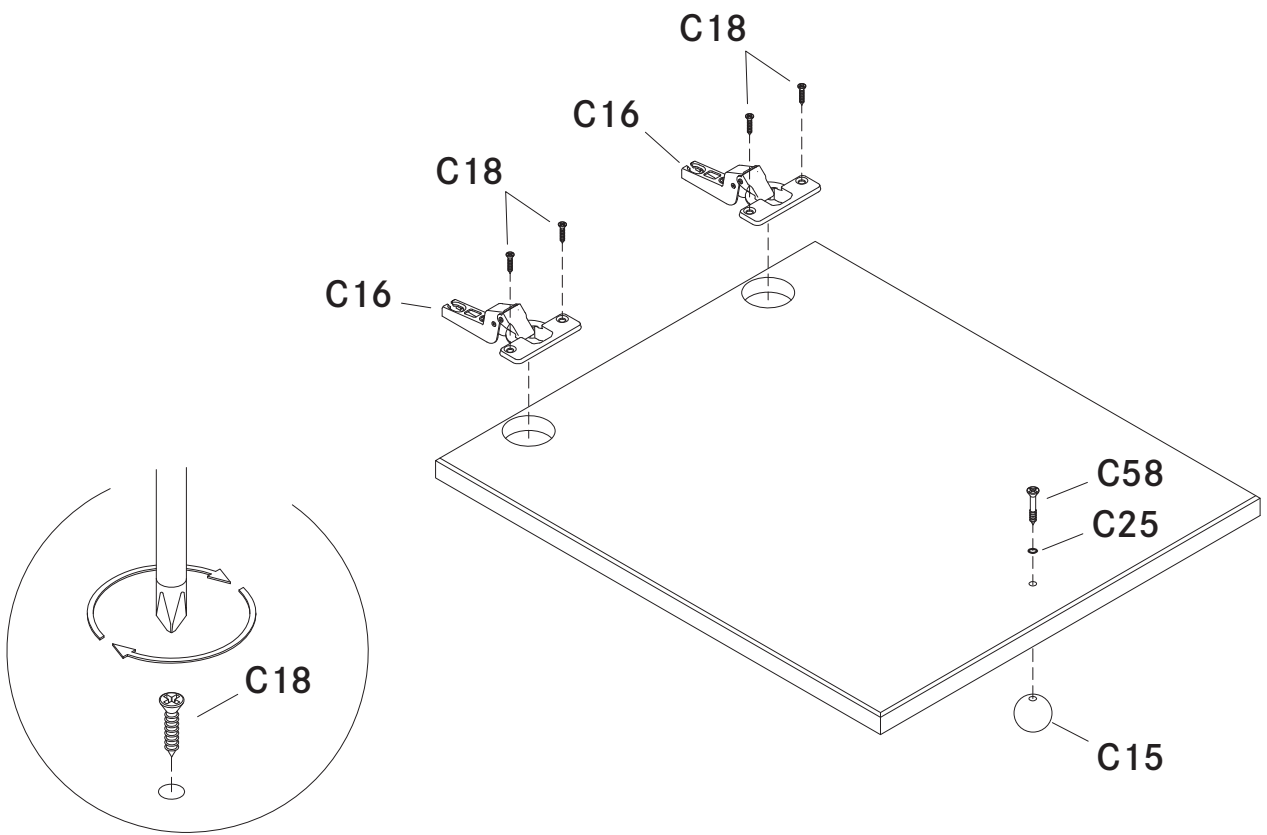

2

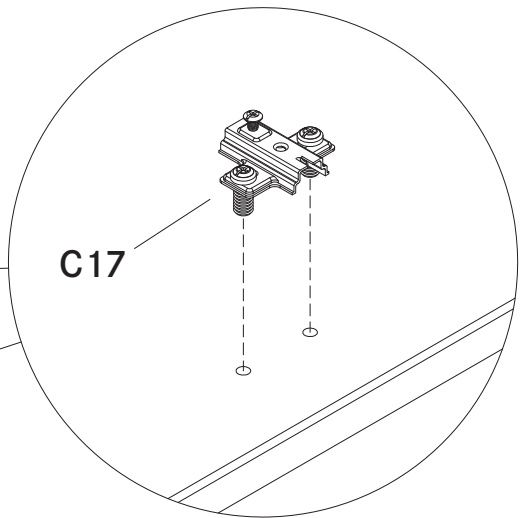
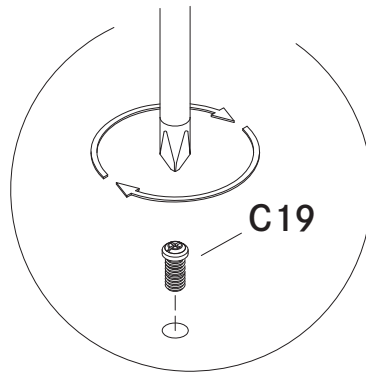
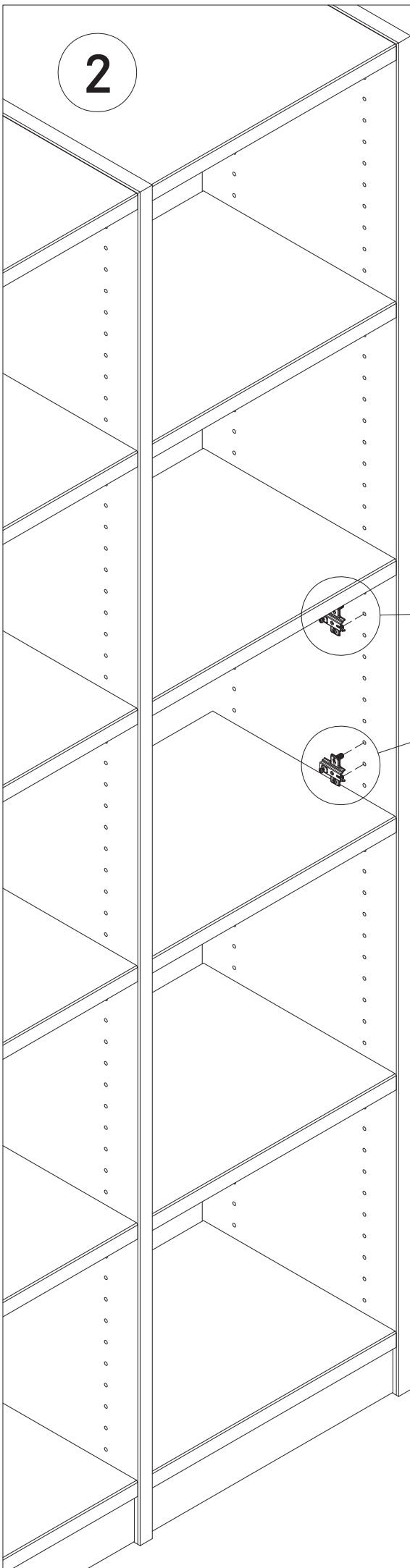

3

